

***BOSE***<sup>®</sup>



---

# A20<sup>™</sup> AVIATION HEADSET

---

Owner's Guide

# SAFETY INFORMATION

**NOTE:** This equipment has been tested and found to comply with the limits for a Class B digital device, pursuant to Part 15 of the FCC Rules. These limits are designed to provide reasonable protection against harmful interference in a residential installation. This equipment generates, uses, and can radiate radio frequency energy and, if not installed and used in accordance with the instructions, may cause harmful interference to radio communications. However, there is no guarantee that interference will not occur in a particular installation. If this equipment does cause harmful interference to radio or television reception, which can be determined by turning this equipment off and on, the user is encouraged to try to correct the interference by one or more of the following measures:

- Reorient or relocate the receiving antenna.
- Increase the separation between this equipment and receiver.
- Connect this equipment into an outlet on a circuit different from that to which the receiver is connected.
- Consult Bose® or an experienced radio/TV technician for help.

Changes or modifications not expressly approved by Bose Corporation could void the user's authority to operate this equipment.

Operation is subject to the following two conditions: (1) This device may not cause harmful interference, and (2) this device must accept any interference received, including interference that may cause undesired operation.



Bose Corporation hereby declares that this product is in compliance with the essential requirements and other relevant provisions of Directive 1999/5/EC and other applicable Directives. The complete Declaration of Conformity can be found at [www.Bose.com/compliance](http://www.Bose.com/compliance).

Operate this product within the temperature range of 5°F to 131°F (-15°C to 55°C) only.

The *Bluetooth*® word mark and logos are registered trademarks owned by Bluetooth SIG, Inc. and any such use by Bose Corporation is under license. All other marks are property of Bose Corporation.

## Important Safety Instructions

- Please read these instructions carefully and completely before using the headset.
- Make these instructions easily accessible to all users at all times. Always include these instructions when passing the headset on to third parties.
- During flight operations, do not use the headset for telephone calls.
- It is the responsibility of each aircraft operator or pilot in command to determine that any and all portable devices will be free of any interference with the navigation or communication system of the aircraft. In addition, it is their responsibility to determine the suitability of the performance of portable devices in relation to the use of the Bose® A20™ Headset.
- The headset is capable of producing sound pressure levels exceeding 85dB(A). In many countries 85dB(A) is the maximum legally permissible level for continuous noise exposure during the working day. Exposure to sounds of higher volume levels or longer durations can permanently damage your hearing.
- Never repair or attempt to repair a defective headset yourself. Contact Bose Technical Support. Refer to "Contact information" on page 37.
- Do not immerse the headphones in water or any other liquid. See "Cleaning the headset" on page 23 for cleaning instructions.
- **Warning:** Choking hazard. Keep the batteries away from children. 
- Danger of explosion if batteries are incorrectly replaced. Replace only with AA alkaline batteries. Batteries may cause a fire or chemical burn if mishandled. Do not recharge, disassemble, heat, or incinerate. Dispose of used batteries properly.

<b>ADVISORIES</b>	<b>1</b>
Operational advisory	1
Hearing safety	2
Volume control	2
Recognizing aircraft sounds	2
Using audio sources	2
Headset earcup requirements	3
Earcup inner screen	3
Storage	3
<b>INTRODUCTION</b>	<b>4</b>
What's included	4
What's in the carton	5
Control module variations	6
Power and cable variations	7
<b>PREPARING THE HEADSET FOR USE</b>	<b>8</b>
The microphone assembly	8
Attaching the microphone assembly	8
The battery compartment	9
Opening the battery compartment	9
The operation switches	9
Inserting and replacing the batteries	10
Connecting the headset to the aircraft	11
Using the 6-pin plug	11
Using the dual general aviation plugs	12
Using other plug types	12
<b>USING THE HEADSET</b>	<b>13</b>
Wearing and adjusting the headset	13
Conditions related to fit	13
Microphone placement	13
Clothing clips	14
Using the control module	15
Power button	15
Volume control	16
Power indicator	16
Auxiliary (AUX) audio input	17
Audio priority	17
Using the headset with a Bluetooth® technology enabled phone	19
Pairing the headset with your phone	19
Bluetooth® volume control	21
Making and answering calls	22

**HEADSET CARE AND MAINTENANCE 23**

---

Instructions for continued airworthiness .....	23
Cleaning the headset .....	23
General cleaning .....	23
Headset earcup openings .....	23
Microphone windscreen .....	24
Earcup inner screen .....	24
Headband cushion .....	24
Replacing parts .....	24
Microphone windscreen replacement .....	24
Ear cushion replacement .....	25
Battery replacement .....	25
Headband cushion replacement .....	26
Microphone assembly or access cover replacement .....	26

**TROUBLESHOOTING 27**

---

In case of difficulty .....	27
-----------------------------	----

**INSTALLATION 31**

---

Mounting the aircraft panel connector .....	31
Details on making the connections .....	33

**TECHNICAL INFORMATION 34**

---

**SERVICE AND WARRANTY INFORMATION 36**

---

Locating the headset serial number .....	36
Warranty period .....	36
Limited warranty service .....	36
To return your headset to Bose for repair .....	36
Contact information .....	37
Ordering parts and accessories .....	37

## Operational advisory

---

The Bose® A20™ Aviation Headset incorporates Acoustic Noise Cancelling® technology. As with any complex electronic device, it is possible for this headset to fail during operation. Symptoms of failure may include loud tones, distortion, and loss of communications signal in the headset when used in the Acoustic Noise Cancelling mode.

---

**Note:** *The headset includes redundant circuitry to reduce the effects of such failures and to allow for continued use of the headset in the passive noise reducing mode.*

---

In passive noise reducing mode, the volume controls on the control module will automatically be set to maximum volume. If additional volume control is needed, you can use the intercom or radio volume control.

Acoustic Noise Cancelling mode is active when the headset control module is powered on (power indicator is lit). The headset is in the passive mode when the power is off (power indicator is not lit). See “Control module variations” on page 6.

If your headset is aircraft powered, connect the headset to the aircraft power sources only as described in “Connecting the headset to the aircraft” on page 11. The headset will not operate properly if used with any battery source other than the Bose A20 Aviation Headset control module.

# Hearing safety

---

The headset is intended for use with the Acoustic Noise Cancelling® mode turned on. Noise reduction and communications performance are reduced with Acoustic Noise Cancelling mode turned off.

## **Volume control**

Make sure your aircraft communications system volume control is easily accessible. This control affects the strength of the communications signal coming into the headset.

As pilot in command, you must be sure you can understand critical communications even with Acoustic Noise Cancelling mode turned off. In this case, you may need to turn up the aircraft communications system volume.

Avoid setting the volume controls at levels high enough to impair your hearing during extended periods of headset use.

## **Recognizing aircraft sounds**

With the headset's active and passive noise reduction, typical aircraft sounds (such as engines, propellers, warning alarms, and other sound sources) may not sound familiar. We strongly advise you to make sure you can hear and recognize these sounds when using the Bose® A20™ Aviation Headset while operating any aircraft.

## **Using audio sources**

When listening to in-flight entertainment, or a portable audio source through a Bose A20 Aviation Headset, be sure to limit the volume to safe levels that do not interfere with your ability to hear informational sounds and warning alarms, such as stall warnings or gear up, while piloting.

## Headset earcup requirements

Proper headset operation requires that the headset TriPort® openings on the earcup are kept free of debris. The headset TriPort openings are located on the outside of each earcup and include two holes and a screen.

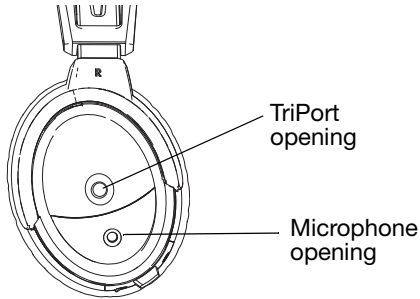

## Earcup inner screen

The protective inner screen is critical to the headset's ability to reduce noise.

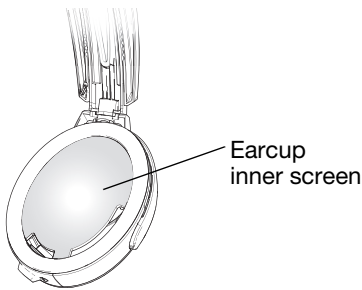

Do not attempt to remove, replace, or repair this screen. If screen replacement seems necessary, contact Bose® Technical Support. See “Contact information” on page 37.

If the screen gets wet or any foreign objects become lodged on or adjacent to it, follow the instructions in “Headset Care and Maintenance” on page 23.

## Storage

Store the headset in a ventilated area away from direct sunlight. Remove the batteries before storing the headset for extended periods.

# INTRODUCTION

---

Congratulations on your purchase of a Bose® A20™ Aviation Headset. The Bose A20 Aviation Headset is our most advanced aviation headset yet. It delivers significantly increased noise reduction and provides a more comfortable fit, without compromising the clear audio you expect from Bose. Plus, it offers auxiliary audio input and is available with *Bluetooth*® wireless technology.

## What's included

---

Each Bose A20 Aviation Headset is supplied with a control module, cable, and carrying case. The type of control module and end-plug configuration depends on the options you chose for your headset.

There are two options for the control module:

- Control module with *Bluetooth* wireless technology.
- Conventional control module

There are several end-plug configurations for the headset. Your headset falls into one of two general categories:

- Dual-powered: Aircraft powered with battery
- Battery-only powered



## What's in the carton

### Headset assembly:

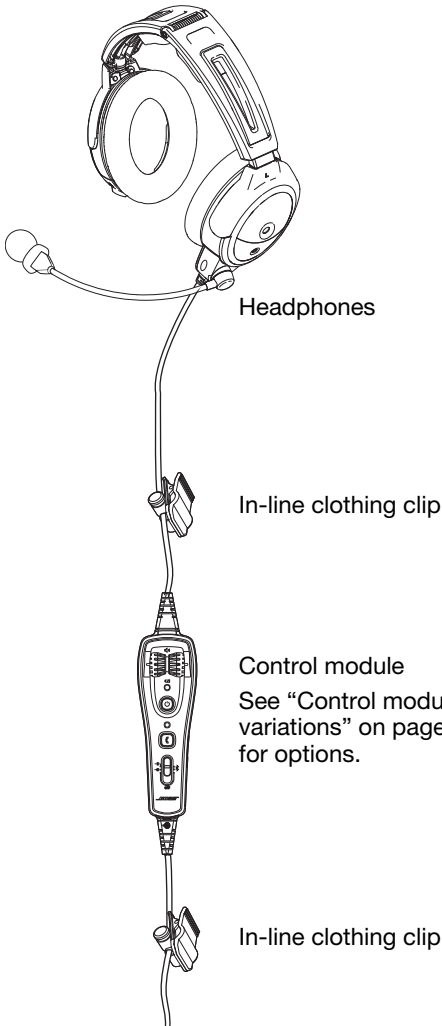

Headphones

In-line clothing clip

Control module  
See "Control module variations" on page 6 for options.

In-line clothing clip

Cable connector (varies)

### Accessories:

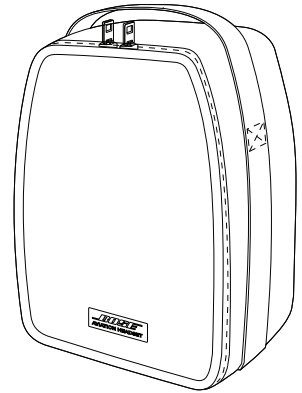

Carrying case



2 AA Alkaline batteries



3.5 mm adapter cable

**Note:** Cable connector types will vary based on model of headset. See "Power and cable variations" on page 7.

## Control module variations

If you opted for *Bluetooth*® wireless technology, you received the control module featuring *Bluetooth* technology. If not, you received the conventional control module.

*Bluetooth* control module

Conventional control module

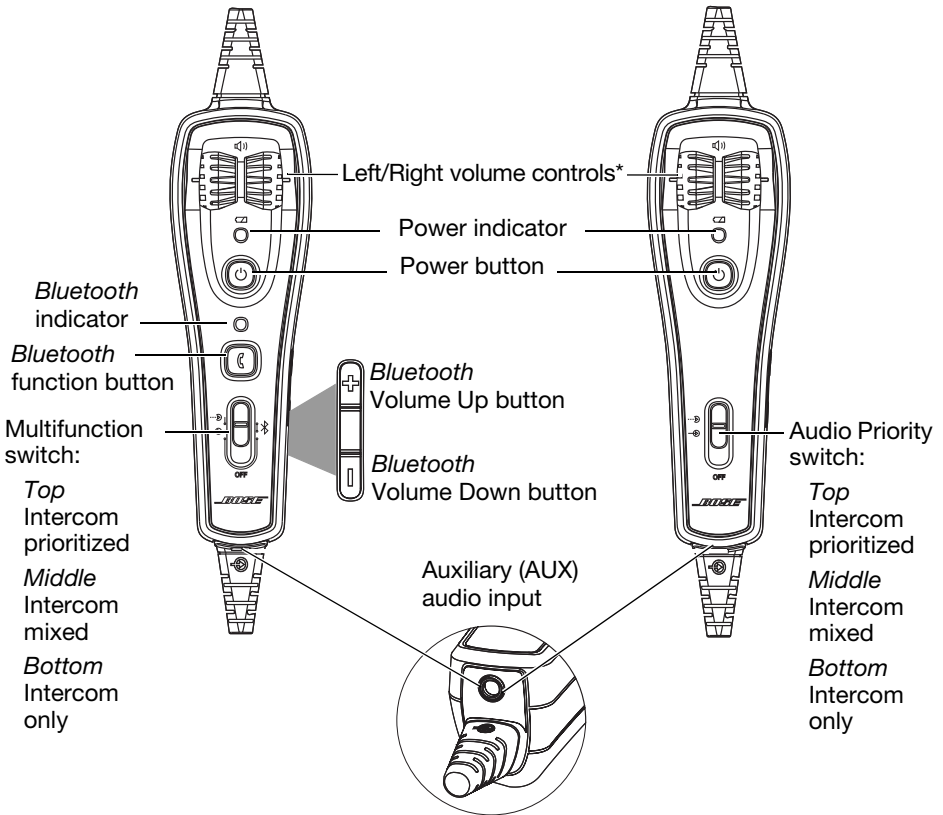

\*Control the intercom volume

## Power and cable variations

The Bose® A20™ Aviation Headset is available for purchase in different standard aircraft connector options to suit pilot needs including:

- Dual G/A
- 6-pin install\*
- 5-pin XLR
- U174

\* An adapter is available from Bose to convert a 6-pin connector to a dual G/A plug for additional connection flexibility. Other configurations require the purchase of a cable assembly.

## PREPARING THE HEADSET FOR USE

---

### The microphone assembly

---

Your headset may be shipped with the microphone assembly (boom microphone and cable) attached to the left earcup. If your headset is shipped with the microphone assembly packed separately, you can attach it to either earcup.

#### Attaching the microphone assembly

Choose the earcup (L or R) to receive the microphone assembly. Also, make sure that the earcup connector pins are clean and free of debris.

1. Use a Phillips screwdriver to loosen the two screws on the access cover near the bottom of the earcup where you want to attach the microphone assembly.
2. Remove the access cover to reveal the connector pins on the earcup.
3. Carefully line up the microphone assembly to the small connector socket on the earcup.
4. Slide the connector into the socket until it reaches the stop.

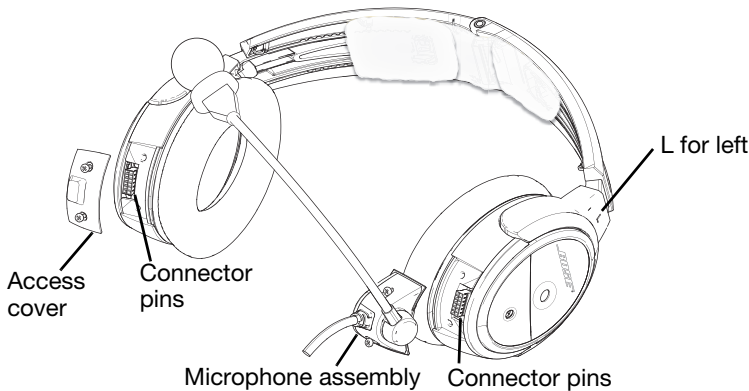

---

**CAUTION:** Do not force the connector into the socket, or earcup damage may occur.

---

5. Tighten the screws to secure the assembly.
  6. Attach the access cover to the earcup that does not have the microphone assembly attached. Insert the screws, then align and tighten them.
- 

**Note:** The headset will not work without the access cover installed.

---

**CAUTION:** Be sure to try the headset and fully test its operation before flight.

---

# The battery compartment

The Bose® A20™ Aviation Headset is shipped with factory-set operation defaults. If you want to alter these defaults, you can change the operation switches located inside the control module battery compartment. If you do not want to change any of the operation switches, skip ahead to “Inserting and replacing the batteries” on page 10.

## Opening the battery compartment

You must open the battery compartment to access the operation switches. Press down firmly on the battery compartment cover finger indent and slide the cover down. The cover is tethered to the module. Do not attempt to detach it.

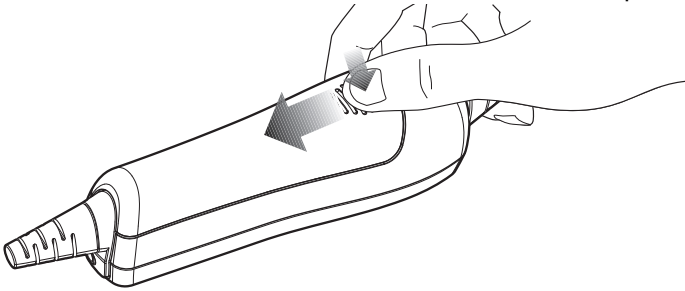

**Note:** The battery compartment cover is designed to remain securely closed. You may need to use additional force when pressing down and releasing cover.

## The operation switches

The operation switches control the Auto Off function and whether you hear mono audio in one or both ears.

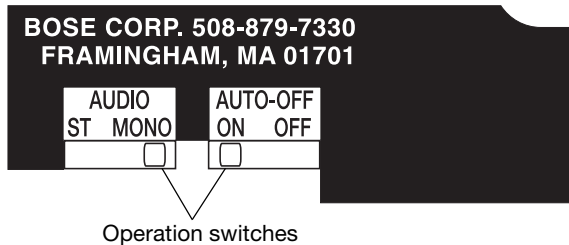

### To change the operation switches

1. Open the battery compartment.
2. If batteries are installed, remove them.

In the battery compartment, you can observe and change the switch positions.

## PREPARING THE HEADSET FOR USE

---

3. To change a switch position, use a pen or a small, flat-tipped screwdriver to gently move the switch.

The following table shows possible positions, default setting, and purpose for each switch.

<b>Switch</b>		<b>Options</b>	<b>Purpose</b>
1.	Auto off function	ON, OFF <b>Default: ON</b>	Set at the factory to enable the Auto Off function. The headset will turn off after 3 to 9 minutes of inactivity. To disable Auto Off, set the switch to OFF. With the switch in OFF position, the Acoustic Noise Cancelling® system will not turn off until you press and hold the power button for at least one second.
2.	Mono/Stereo selection	Mono, Stereo <b>Default: MONO</b>	Set at the factory for mono audio systems (to provide audio in both ears). Set it to stereo (ST) if your aircraft has a stereo intercom.

### **Auto Off functionality**

The Auto off feature detects when the headset is not in use and shuts it off after several minutes to preserve battery power. The exact time it takes to shut off varies and can range between 3 to 9 minutes after you stop using the headset.

When the headset is running on battery power only and is not plugged in to an intercom, it will shut off even when there is an auxiliary input present.

If you are on a phone call and unplugged from an intercom, the headset will allow you to complete your call, then it will turn off approximately three seconds after the call is terminated.

---

**Note:** *To use the headset when unplugged from the intercom to listen to auxiliary input audio or as a Bluetooth® wireless technology enabled headset to make or receive calls, we recommend you disable the Auto Off feature for uninterrupted functionality.*

---

### **Inserting and replacing the batteries**

---

**CAUTION:** *If the batteries do not fit correctly, do not force them in. Forcing an improper connection will cause permanent damage to the control module.*

---

#### **To insert or replace the batteries**

1. Turn off headset power.
2. Press down firmly on the battery compartment cover and slide the cover to release. The battery door is tethered. Do not detach the door from the control module.
3. Insert the two supplied alkaline AA batteries into the control module, observing proper polarity.
4. Replace the battery compartment cover.

---

**Note:** *Rechargeable batteries will alter the accuracy of the battery power indicator.*

---

# Connecting the headset to the aircraft

The Bose® A20™ Aviation Headset can be configured to either plug into aircraft power or rely entirely on battery power.

## Using the 6-pin plug

A single 6-pin plug inserted into the 6-pin connector provides the headset with aircraft power and intercom audio.

If your headset is aircraft powered, a 6-pin connector must be installed and mounted to an aircraft panel. See “Mounting the aircraft panel connector” on page 31.

**Note:** An adapter is available from Bose to convert a 6-pin connector to a dual G/A plug for additional connection flexibility.

### To connect the headset

1. Align the 6-pin plug to the connector keyway by matching the narrow bar on the plug to the slot on the connector.
2. Firmly press the plug into the connector jack.

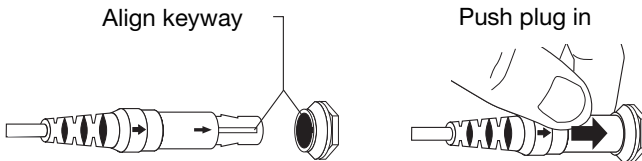

### To disconnect the headset

1. Pull back on the sleeve near the end of the 6-pin plug.
2. Gently continue pulling back to remove the plug from the connector.

**CAUTION:** Do not pull the connector out without first pulling back the sleeve. Forcing the connector out will damage the cable and/or the aircraft instrument panel.

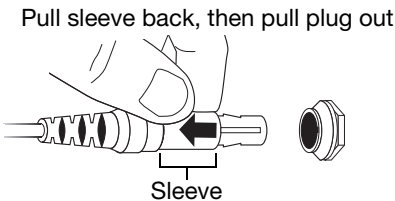

### Using the dual general aviation plugs

The most common battery powered (only) version of the headset has two general aviation (G/A) plugs that connect to the aircraft audio. Although the plugs look similar, the microphone plug is shorter, thinner, and has a slightly different shape than the intercom plug.

Insert the thicker intercom plug in first. It will only fit into one of the jacks. Then insert the thinner microphone plug into the other jack.

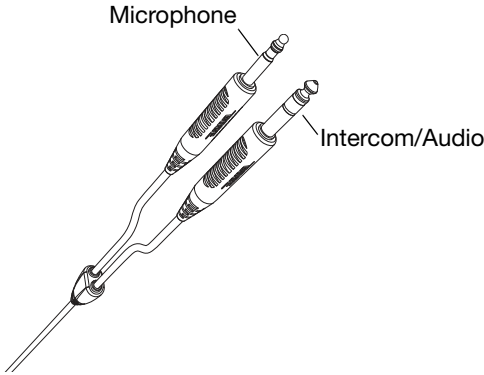

### Using other plug types

The Bose® A20™ Aviation Headset is also available with other types of plugs for connecting to various aircraft audio jacks. These single plug connectors should be inserted into the appropriate jack on your aircraft control panel. See “Power and cable variations” on page 7.



## Wearing and adjusting the headset

Proper fit on your head is important both for comfort and optimal noise reduction performance. Here are a few guidelines:

- Use the left (L) and right (R) markings above the earcups to orient the headset properly.

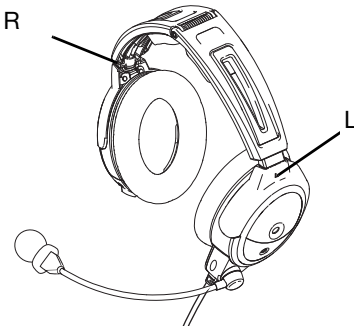

- As you put the headset on, lightly grasp each earcup and adjust it so its cushion is completely over your ear. You should feel an even, gentle pressure all around each ear.
- Adjust the headband so it rests gently on top of your head.

Make your final adjustments with the headset powered on in a noisy environment.

In very loud conditions, such as during takeoff, you may experience a brief reduction in Acoustic Noise Cancelling® as the headset compensates for a momentary pressure change. If the problem continues when the sound level returns to normal, refer to “In case of difficulty” on page 27. If the problem persists, contact Bose® Technical Support for assistance.

### Conditions related to fit

A low rumbling sound or frequent, brief losses of Acoustic Noise Cancelling noise reduction may indicate an improper fit or blocked earcup ports. See “Headset earcup openings” on page 23 for instructions on removing blockages.

During a long flight, you may feel a slight pressure point, which can be relieved by adjusting the headband position. Your experience with using the headset will help establish a sense of how it should sound and feel.

### Microphone placement

Microphone placement is important for clear communications. With the headset on your head, make these adjustments:

## USING THE HEADSET

1. Grasp the boom with your fingers and move the microphone up or down so it is level with your mouth.
2. Pull the microphone in toward your lips. Position the microphone with its talk side facing in. Though it will be slightly off center, the microphone should be  $\frac{1}{2}$  inch from the opening of your lips.

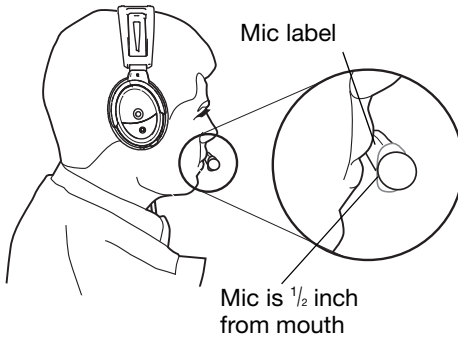

Mic is too far away



Mic label is not facing mouth



3. Make sure the talk side of the microphone is facing your lips. Do not purse your lips.

## Clothing clips

The control module cable is fitted with two clothing clips. Use the clips to attach the headset cable to your clothing, a safety harness, or an aircraft door pocket.

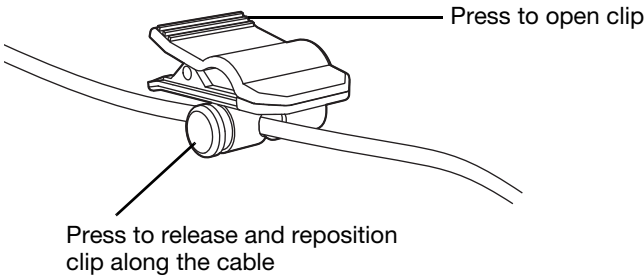

# Using the control module

Use the control module to control the headset functions. There are two variations of the module; one featuring *Bluetooth*® wireless technology and one that has basic functions only.

**Bluetooth control module**

**Conventional control module**

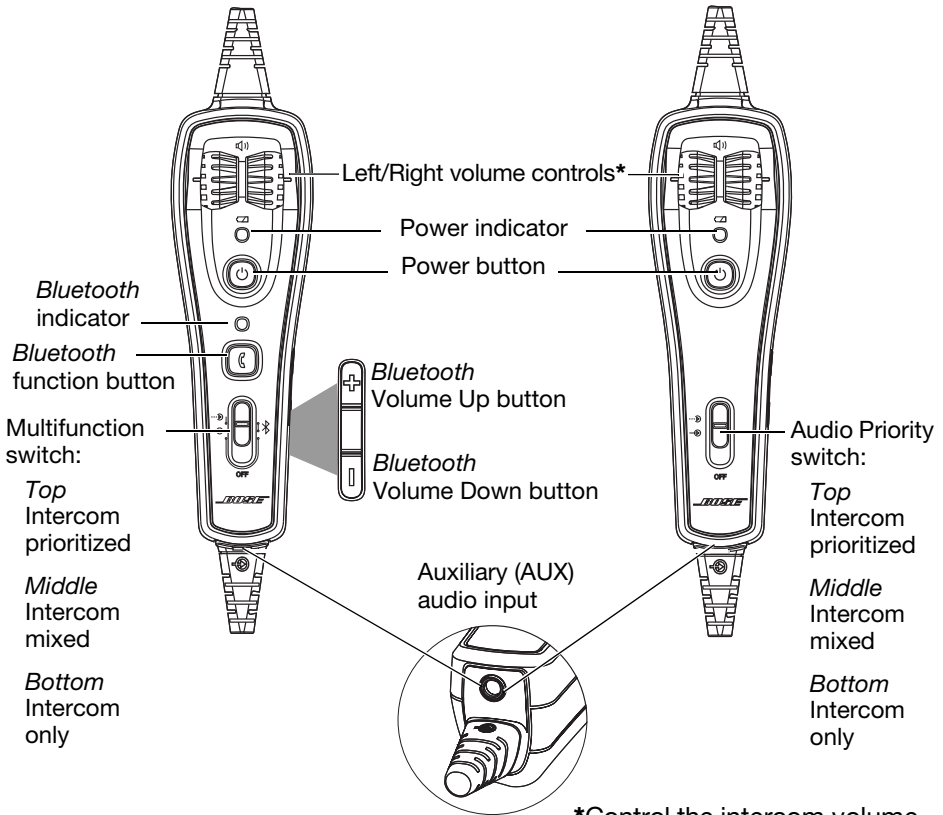

## Power button

Use the power button to turn Acoustic Noise Cancelling® on or off, and control indicator brightness.

- Press the power button once to turn on Acoustic Noise Cancelling noise reduction.
- Press and hold the power button to turn off Acoustic Noise Cancelling noise reduction.

## USING THE HEADSET

---

- Double-click the power button to dim the power and *Bluetooth*<sup>®</sup> wireless technology indicators. To toggle the indicators between dim and bright, rapidly press the power button twice.

### Volume control

The left and right volume control wheels on the control module adjust the volume of the corresponding earcup. With Acoustic Noise Cancelling<sup>®</sup> off, volume control will be set to the maximum level.

---

**CAUTION:** *Avoid setting the volume levels too high. Exposure to loud sounds may cause hearing damage.*

---

Holding the control module upright and facing you:

- Use the left wheel to adjust volume of the left earcup.
- Use the right wheel to adjust volume of the right earcup.

Overall headset volume control requires adjustments at both the aircraft intercom or radio and at the headset control module. Even at its lowest setting, neither volume control wheel can completely turn off the volume.

### Power indicator

New alkaline AA batteries will generally supply at least 40 hours of power for the headset. Battery life varies with the ambient noise level of the aircraft, temperature, ear cushion condition, and age of the batteries. The power indicator changes color to indicate the power status, as follows:

Indicator color	Power source	Type of light	Indicates
Green	Aircraft	Slow flashing	Power ON
Green	Battery	Flashing	Power ON and batteries good
Amber	Battery	Fast flashing	Power ON, but batteries low (8 hours or less remaining)
Red	Battery	Faster flashing	Power ON, but batteries very low* (2 hours or less remaining)
Off	None	None	Power OFF or batteries depleted

\* *Bluetooth* wireless technology is disabled to conserve the remaining power once the battery reaches this level.

## Auxiliary (AUX) audio input

The Bose® A20™ Aviation Headset provides a 1/8 inch (3.5 mm) AUX audio input that allows you to use your headset with an external audio source such as a portable GPS or a portable audio device. The connector is located at the bottom end of the control module as shown.

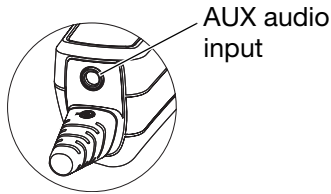

Your headset includes a 1/8 inch (3.5 mm) adapter cable to connect your external audio device. Plug one end of the adapter cable into the headphone plug on your device and the opposite end into the headset AUX audio input.

---

**Note:** None of the functions of a connected audio source are controlled by the control module.

---



---

**Note:** This feature will not work unless the multifunction switch is turned on.

---



---

**Note:** When the headset is running on battery power only and it is not plugged into an intercom, it will shut off even when there is an auxiliary audio input present. To use the headset when unplugged from the intercom to listen to auxiliary input audio or as a Bluetooth® wireless technology headset to make or receive calls, we recommend you disable the Auto Off feature for uninterrupted functionality.

---

## Audio priority

The Bose A20 Aviation Headset allows you to decide the priority of the audio sources you want to hear while using the headset. On the *Bluetooth* control module, the audio priority is controlled by the multifunction switch. On the conventional control module, the audio priority is controlled by the audio priority switch.

### Multifunction/Audio priority switch

The multifunction/audio priority switch has three positions:

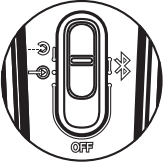
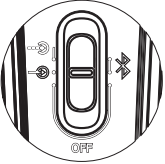
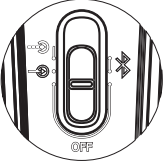
Position	Function	Operation
Top 	Intercom prioritized over AUX	When the switch is in the top position and an intercom signal is detected, AUX audio is muted.
Middle 	Intercom mixed with AUX	When the switch is in the middle position and an intercom signal is detected, AUX audio is mixed with the intercom audio.
Bottom 	Intercom only	When the switch is in the bottom position, only intercom audio is active.

**Note:** On the Bluetooth® control module, when a Bluetooth wireless technology call is present, the audio from the call takes over the signal on the AUX audio input. Regardless of the position of the multifunction switch, both the intercom and the Bluetooth wireless technology signal are heard as mixed.

# Using the headset with a *Bluetooth*<sup>®</sup> technology enabled phone

## Pairing the headset with your phone

Before you use your Bose<sup>®</sup> A20™ Aviation Headset with your mobile phone, you must pair the two devices. This entails putting the Bose A20 Aviation Headset in pairing mode, setting your *Bluetooth* technology phone to “discover” the headset, then confirming the connection on the phone.

1. Make sure the headset is powered on, and the multifunction switch is in the top or middle position, but NOT in the bottom (intercom only) position.

Power On  
(indicator lit)

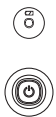

Multifunction Switch in  
top or mid position

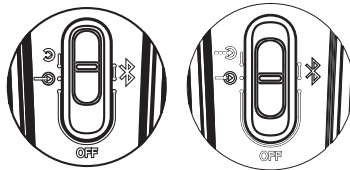

2. Press the *Bluetooth* function button to activate *Bluetooth* technology.
3. To put the headset in pairing mode, press and hold the *Bluetooth* function button on the control module for at least five seconds.



The headset emits a long, low-pitched beep when it enters pairing mode and the *Bluetooth* indicator glows.

4. Set your *Bluetooth* technology phone to “discover” your headset.

 Your phone’s instruction guide will give you the necessary directions. This usually involves going to a “setup,” “connect,” or “*Bluetooth*” menu on your **phone** and selecting the option to “discover” or “add” a *Bluetooth* device.

Your phone will find the Bose A20 Aviation Headset. Your phone then asks if you want to pair with the headset.

The device name “BOSE A20” will appear on the phone.

5. On the phone, accept by pressing “Yes” or “OK” and confirm with the passkey or PIN of **0000** (four zeros).

 Your phone indicates when pairing is complete: the *Bluetooth* indicator and power indicator on the control module flash in synchronization with each other. If pairing is unsuccessful, repeat steps 1 to 3.

**Note:** The Bose A20 Aviation Headset will automatically exit pairing mode after five minutes of inactivity.

### **Bluetooth® status indicator**

The *Bluetooth* status indicator is a blue LED on the control module that indicates the status of the *Bluetooth* wireless technology function, as follows:

Type of light	Indicates
Long slow rate flashes	Discoverable or pairing
Flash pattern: fast, double flash initiated at each power indicator light flash	<i>Bluetooth</i> technology ON and not connected to phone
Flash pattern: synchronized at the same rate with the power indicator light (Green and Amber)	<i>Bluetooth</i> technology ON and connected to phone
OFF	<i>Bluetooth</i> technology not enabled

### **Reconnecting to a previously connected phone**

To reconnect the headset to a previously connected phone or other *Bluetooth* wireless technology device, briefly press the *Bluetooth* function button on the headset control module.

The headset control module attempts to connect with the last connected *Bluetooth* wireless technology device.

---

**Note:** *The Bose® A20™ Aviation Headset can only be connected to one Bluetooth wireless technology device at a time. If you press the Bluetooth function button on the headset control module for more than five seconds, the currently connected Bluetooth wireless technology device is disconnected and the control module enters pairing mode.*

---

### **Recovering a lost connection**

When a connected *Bluetooth* wireless technology device moves out of range and the connection is lost, the Bose A20 Aviation Headset automatically attempts to reconnect. If a connection still does not exist after five minutes, the *Bluetooth* wireless technology receiver in the control module remains on, but not connected. The *Bluetooth* indicator on the Bose A20 Aviation Headset control module will exhibit a fast double flash initiated at each power indicator flash.

### **Disconnecting a Bluetooth technology enabled phone**

If you use a connected phone to end a *Bluetooth* wireless technology connection, the *Bluetooth* technology receiver in the headset control module remains on, but no longer attempts to connect. A *Bluetooth* wireless technology connection is ended by turning the phone off, ending the current call, or discontinuing the wireless connection.

If you turn the headset control module off, the control module *Bluetooth* wireless technology receiver also turns off, ending the connection to the *Bluetooth* technology enabled phone.



## Bluetooth® volume control

The *Bluetooth* volume control increases or decreases the volume of the mobile phone that is paired to the Bose® A20™ Aviation Headset. The *Bluetooth* volume control is located on the right side of the control module. You can only adjust the *Bluetooth* technology volume during an active phone call. To change the volume, press the volume up or volume down button.

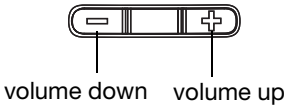

Each time you press a *Bluetooth* volume button, the volume increases or decreases one level.

---

**Note:** Pressing and holding the volume button does not cause the volume to change by more than one level.

---



---

**Note:** When Bluetooth wireless technology is active, you cannot mute the sound using the Bluetooth volume buttons.

---

### To clear pairing device history from the headset

With Bluetooth technology enabled and on (Bluetooth indicator light flashing) while not in a call, press and hold both Bluetooth volume up and Bluetooth volume down buttons at the same time for 8 seconds. After 8 seconds, cycle the Bluetooth power using the multifunction switch.

### Making and answering calls



#### To make a call



Dial from your mobile phone, and the call will automatically transfer to the headset. If your phone has voice-activated dialing, press the *Bluetooth*<sup>®</sup> function button and wait for the phone voice prompts.

#### To activate voice dialing

When there are no active or incoming calls, briefly press the *Bluetooth* function button.

#### To answer a call

Briefly press the *Bluetooth* function button. You should hear a short beep in the headphones before you hear the incoming call.

#### To end a call

Briefly press the *Bluetooth* function button. You should hear two short beeps in the headphones to indicate that the call has been ended.

#### To reject an incoming call

Press the *Bluetooth* function button for three seconds.

---

**Note:** To avoid putting the control module into pairing mode, do not press the *Bluetooth* function button for more than five seconds.

---

#### To redial the last number

When there are no active or incoming calls, press the *Bluetooth* function button twice in quick succession.



**Note:** Whether or not you can reject an incoming call, activate voice dialing, or redial the last number depends on the capabilities of your phone. Please check your phone user guide for further details.

---

#### To transfer the audio to the mobile phone

When you are on a call, press the *Bluetooth* function button for three to four seconds. This transfers the audio to the mobile phone handset while the *Bluetooth* wireless technology connection remains active.

---

**Note:** If you are on a call and unplugged from an intercom, the headset will allow you to complete your call, then it will turn off approximately three seconds after the call is terminated. To use the headset when unplugged from the intercom to listen to auxiliary input audio or as a standalone *Bluetooth* technology headset to make or receive calls, we recommend you disable the Auto-Off feature for uninterrupted functionality.

---

## Instructions for continued airworthiness

Bose recommends following the general care and maintenance instructions in this guide. With normal use, items such as windscreens and ear cushions may require periodic replacement. If cleaning or replacement of these items is needed, follow the recommendations on the following pages. All other care and maintenance, in and out of the warranty period, must be performed by Bose or an authorized repair facility.

**CAUTION:** Do not immerse the headset in water or any other liquid. If the headset is immersed in liquid, do not use it. Contact Bose® Technical Support for assistance.

## Cleaning the headset

### General cleaning

Gently wipe the outside surfaces of the headband, connectors, plastic parts, and headband cushion, using a soft cloth moistened with water and mild soap. Take special care when cleaning the ear cushions and the outside surfaces of the earcups. Do not immerse ear cushions in water or any other liquid.

### Headset earcup openings

The headset TriPort® opening and the microphone opening must remain clean and free of debris. Check to ensure that the openings on each earcup are clean before each flight.

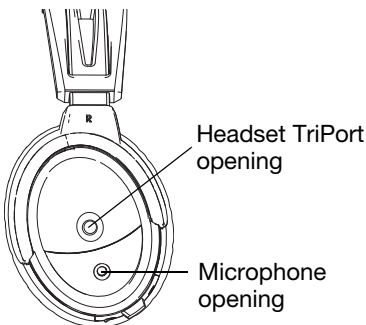

When wiping down the headset earcups, be sure not to force any dirt or debris into the openings. Carefully use tweezers, if necessary, to remove foreign matter that may be lodged in the openings. Do not blow air into or vacuum the openings as this may damage the headset.

### Microphone windscreen

Remove the windscreen from the microphone as described in “Microphone windscreen replacement,” below.

Rinse and air dry the windscreen. Make sure the windscreen is completely dry, then reattach.

### Earcup inner screen

*Do not* attempt to remove, replace, repair, or clean this component. Located inside the earcup, the inner screen is critical to proper headset operation. If the screen appears to be damaged or worn out, contact Bose.

If the inner screen becomes damp from environmental moisture such as light rain, dew, perspiration, or condensation, allow it to air dry only. Do not use electric heaters, blowers, or hairdryer-type devices to dry the inner screen.

### Headband cushion

1. Remove the cushion as described in “Headband cushion replacement” on page 26.
2. Place the cushion in a solution of water and a mild detergent.
3. Allow the cushion to air dry, then, reattach.

## Replacing parts

---

Through normal use, parts like windscreens and ear cushions may require periodic replacement. Replacement parts can be ordered directly from Bose Corporation. Please refer to “Contact information” on page 37.

### Microphone windscreen replacement

1. Roll the band that secures the windscreen off the tip of the microphone and dispose of it.
2. Gently slide the windscreen off the microphone.
3. Slide the replacement windscreen on and make sure that it fits completely over the microphone.
4. Roll the new band onto the microphone tip, to about  $\frac{1}{4}$  inch from the end of the windscreen, to secure it.

## Ear cushion replacement

As a general rule, ear cushions should be replaced every six months or every 350 hours of use, depending on how often you fly. You may have to replace them more often, if you:

- Have a full beard or heavy whiskers.
- Subject the headsets to severe temperature extremes such as parking your airplane outside in severe cold or heat.
- Put excess strain on the cushions because of improper storage.

Indications that the ear cushions need replacing include:

- Flaking of the outer covering.
- Cuts or tears.
- Flattening of the cushion, reducing the effectiveness of the seal.

To extend the life of the ear cushions, perform regular cleaning as described in “General cleaning” on page 23.

### Replacing the ear cushions

1. Grasp the ear cushion skirt where it folds into the slot on the earcup.
2. Gently pull the ear cushion skirt up and away from the earcup.

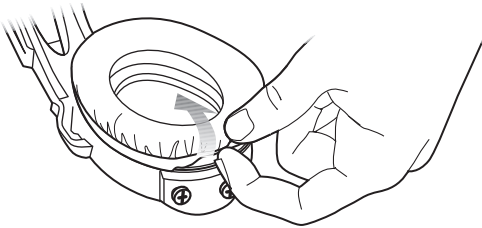

3. Properly align the replacement ear cushion with the earcup.
4. Tuck an edge of the ear cushion skirt into the slot behind the ear cushion flange. Be careful not to fold the skirt over.
5. Work the remainder of the skirt into the slot completely around the earcup.
6. Grasp the ear cushion and adjust its position to remove any folds in the skirt and wrinkles in the cushion.

## Battery replacement

See “Inserting and replacing the batteries” on page 10.

### Headband cushion replacement

The headband cushion is designed to give the maximum level of comfort to your headset.

Bose recommends that you replace the cushion after regular care and maintenance fails to restore the wool pile to its original size and shape.

To replace the cushion:

1. On a protected surface, turn the headset upside down. Remove the old cushion from the headband.
2. While still holding the headband open, align the center of the new cushion with the center of the headband and press firmly from the center toward the outside.

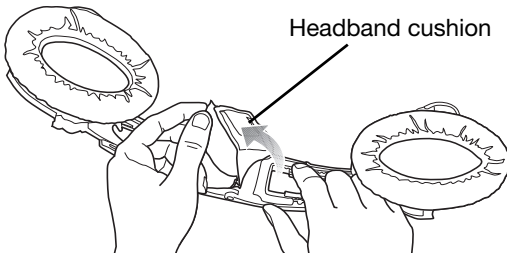

### Microphone assembly or access cover replacement

Replace the microphone assembly or connector access cover as described in “Attaching the microphone assembly” on page 8.

## In case of difficulty

Look for the problem in the left column of the table, then follow the “What to do” instructions in the right column. If the problem persists, contact Bose using the contact information on page 37 of this guide for assistance.

**CAUTION:** Do not attempt to disassemble or service the inside of the earcups or other parts of the headset. Only the boom microphone cable, access cover, batteries, windscreen, headband cushion, and ear cushions are replaceable by the user. For instructions on how to care for and maintain the headset, see “Headset Care and Maintenance” on page 23.

### Noise Reduction

Problem	What to do
Communication, but no Acoustic Noise Cancelling® noise reduction in either ear.	<ul style="list-style-type: none"> <li>• Make sure the headset is powered on. The headset will not turn on automatically when connected to the aircraft. Press the power button to turn the headset on.</li> <li>• Check the power indicator. See page 16 for a description of the power indicator.</li> <li>• If using aircraft power, check the aircraft fuse or circuit breaker.</li> <li>• If using battery power, make sure the batteries are fresh and correctly installed.</li> </ul>
No active Acoustic Noise Cancelling noise reduction and no communication.	<ul style="list-style-type: none"> <li>• Make sure the headphone jacks are securely inserted into the panel.</li> <li>• Try using the headset in a different seat location.</li> <li>• Remove cable assembly from the headset and check for damage to connector or pins.</li> </ul>

### Communications

Problem	What to do
Acoustic Noise Cancelling noise reduction, but no incoming audio.	<ul style="list-style-type: none"> <li>• Check to see if the volume controls are set too low. See “Volume control” on page 16 for instructions on volume adjustment.</li> <li>• Check the volume setting of intercom/radio.</li> <li>• Make sure the headphone jacks are securely inserted into the panel.</li> </ul>

## TROUBLESHOOTING

Problem	What to do
Low volume of incoming communications.	<ul style="list-style-type: none"> <li>• Check to see if the volume controls are set too low. See “Volume control” on page 16 for instructions on volume adjustment.</li> <li>• Ensure that the stereo/mono switch is correctly set for your intercom system.</li> <li>• Check that all headsets sharing the intercom have the stereo/mono switch in the correct position.</li> <li>• Unplug all other headsets and see if the volume can be adjusted to an acceptable level.</li> </ul>
Intermittent communication.	<ul style="list-style-type: none"> <li>• Check that the connection to the aircraft panel is not loose.</li> <li>• Try the headset in a different seat location.</li> </ul>
Reduced volume in one ear only.	<ul style="list-style-type: none"> <li>• Check to see if the volume control is set too low. See “Volume control” on page 16 for instructions on volume adjustment.</li> <li>• Check the stereo/mono configuration switch. See “The operation switches” on page 9.</li> </ul>
No stereo separation or communications in one ear only.	<ul style="list-style-type: none"> <li>• If your aircraft has a mono audio system, verify that the stereo/mono configuration switch is set to mono. See “The operation switches” on page 9. Depending on how your audio jacks are wired, there may be only one channel of audio supplied to the headphone jack. If the stereo/mono switch is set to stereo and you only hear communications on one side, setting the switch to mono plays audio on both sides.</li> </ul>

## Audio

Problem	What to do
Reduced Acoustic Noise Cancelling® noise reduction, intermittent clicking sounds, or communication distortion in a loud environment.	<ul style="list-style-type: none"> <li>• Check the TriPort® headset openings on the outside of each earcup to ensure that they are not blocked. If dust or dirt is present, carefully remove the debris using tweezers. Do not vacuum or blow out debris.</li> <li>• Make sure there are no air gaps around the ear cushion seals. If ear cushions appear worn, they should be replaced. See “Ear cushion replacement” on page 25.</li> </ul>
Squealing or whistling sound when the headset is turned on.	<ul style="list-style-type: none"> <li>• Ensure the headset orientation is correct. Use the Left (L) and Right (R) markings above the earcups to orient the headset correctly.</li> <li>• Inspect the seal between the ear cushion skirt and the earcup. The skirt should fit into the slot on the earcup with no gaps. Replace any cushions that appear to be worn out.</li> <li>• Adjust the earcup fit to create a better seal on your head. The headset’s low-force design makes it sensitive to items that interfere with the seal around your ear. Make sure your ears are completely inside the ear cushions, and that a hat or eyeglasses with thick temples do not interfere with the seal.</li> </ul>



<b>Problem</b>	<b>What to do</b>
<p>Low rumbling sound with the headset turned on in a quiet environment.</p>	<ul style="list-style-type: none"> <li>• Adjust the earcup fit to create a better seal on your head. The low-force design of the headset makes it sensitive to items that interfere with the seal around your ear. Make sure your ears are completely inside the ear cushions, and that a hat or eyeglasses with thick temples do not interfere with the seal.</li> <li>• Check ports at the outside surface of each earcup to ensure that they are not blocked. If dust or dirt is present, carefully remove the debris using tweezers. Do not blow out or vacuum debris.</li> <li>• Inspect the seal between the ear cushion skirt and the earcup. The skirt should fit into the slot on the earcup with no gaps. Replace any cushions that appear to be worn out.</li> </ul>
<p>Crackling sound audible with headset turned on in a loud environment, or Acoustic Noise Cancelling® noise reduction is intermittent.</p>	<ul style="list-style-type: none"> <li>• Ensure the headset orientation is correct. Use the Left (L) and Right (R) markings above the earcups to orient the headset correctly.</li> <li>• Adjust the earcup fit. See “Wearing and adjusting the headset” on page 13.</li> <li>• If your headset is battery powered, check to see if the battery is low (indicated by fast blinking red LED).</li> <li>• If your headset is aircraft powered, make sure that the voltage powering the headset is no less than 10 VDC.</li> <li>• Inspect the seal between the ear cushion skirt and the earcup. The skirt should fit into the slot on the earcup with no gaps. Replace any cushions that have surface tears, torn stitching joints, large wrinkles, or have become dried and stiff.</li> </ul>

**Auxiliary audio input**

<b>Problem</b>	<b>What to do</b>
<p>No audio from auxiliary source.</p>	<ul style="list-style-type: none"> <li>• Use a different headset with the source you want to hear to isolate the issue to the headset.</li> <li>• Turn source volume up.</li> <li>• Make sure multifunction switch is not set to the bottom (intercom only) position. The multifunction switch must be either in the top or middle position for audio from an auxiliary input to be enabled.</li> <li>• Check the connection between the auxiliary source and the control module. Both ends of the AUX IN connector cable must be properly seated inside the sockets.</li> <li>• If the multifunction switch is set to the prioritized position (top), the auxiliary audio source will not be heard if there is an audio signal from the intercom.</li> </ul>
<p>Audio in one ear only from the auxiliary input.</p>	<ul style="list-style-type: none"> <li>• Check the connection between the auxiliary source and the module. Both ends of the AUX IN connector cable must be properly seated inside the sockets.</li> <li>• Make sure the earcup cover on the headset is in place and properly connected. See “Attaching the microphone assembly” on page 8.</li> </ul>

## TROUBLESHOOTING

Problem	What to do
Cannot hear communications while listening to audio from AUX input or AUX input does not mute with incoming communications.	<ul style="list-style-type: none"><li>• Check headset prioritization settings. See “Multifunction/Audio priority switch” on page 18.</li><li>• Make sure all connections are secure (headset to intercom, AUX input to headset).</li><li>• Communications audio is not present unless the headset is connected to an intercom system.</li></ul>

### **Bluetooth® wireless technology**

Problem	What to do
No audio to the headset while on a call.	<ul style="list-style-type: none"><li>• Check to make sure the headset and phone are paired, the multifunction switch is in the top or middle position, and the devices are communicating with each other.</li><li>• Make sure the phone and headset are in range of the <i>Bluetooth</i> wireless technology (no more than 30 feet from each other).</li><li>• Make sure the volume of the <i>Bluetooth</i> wireless technology is turned up on the control module.</li></ul>
The headset is not pairing with my phone.	<ul style="list-style-type: none"><li>• Follow your phone instructions to remove all devices previously paired with your phone.</li><li>• Repeat the steps for pairing the headset with your phone. See “Pairing the headset with your phone” on page 19.</li></ul>
I cannot answer/end a call.	<ul style="list-style-type: none"><li>• Make sure your phone is properly paired and connected to the headset. See “Making and answering calls” on page 22.</li></ul>
The headset does not reconnect to my phone when I turn it on.	<ul style="list-style-type: none"><li>• Make sure the phone has <i>Bluetooth</i> wireless technology enabled.</li><li>• Turn the multifunction switch on to the top or middle positions.</li><li>• Press the <i>Bluetooth</i> function button.</li></ul>

### **Auto off**

Problem	What to do
Headset does not shut off automatically.	<ul style="list-style-type: none"><li>• In the battery compartment, make sure Switch #1 is set to ON (default).</li><li>• See “The operation switches” on page 9 for details on Auto Off functionality.</li><li>• It may take up to nine (9) minutes for the headset to shut off when not in use immediately after initial power up.</li></ul>

## Mounting the aircraft panel connector

The aircraft panel connector is part of the optional 6-pin wiring harness assembly.

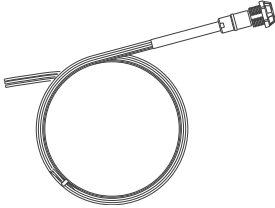

Contact Bose® Technical Support, using the contact information on page 37 of this guide for purchase information.

**CAUTION:** The aircraft panel connector must be mounted by a technician who is qualified to perform this type of avionics installation for the aircraft you are using.

Mount the connector into a cutout, using the diagrams below as a guide.

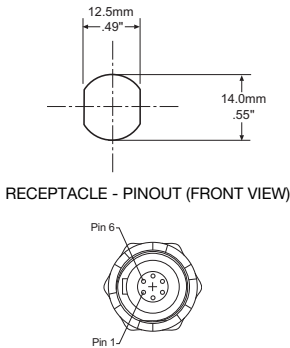

AIRCRAFT INTERFACE SCHEMATIC

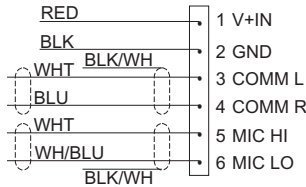

Connect the eight wires as follows:

- Two for the microphone
- Two for audio
- One for power
- One for ground
- Two for audio shields

Audio and microphone wires should be connected to the back of the existing microphone and headphone jacks, leaving existing jacks intact for use with conventional headsets. This is usually the fastest installation method.

## INSTALLATION

**CAUTION:** Do not use excessive force or bend the installed connector. This may damage or break internal solder joints.

**Note:** The aircraft panel connector cannot be installed in an audio system using transformer-coupled audio outputs. Contact the Bose® Technical Support, using the contact information on page 37 of this guide for details.

### Mono connection diagram

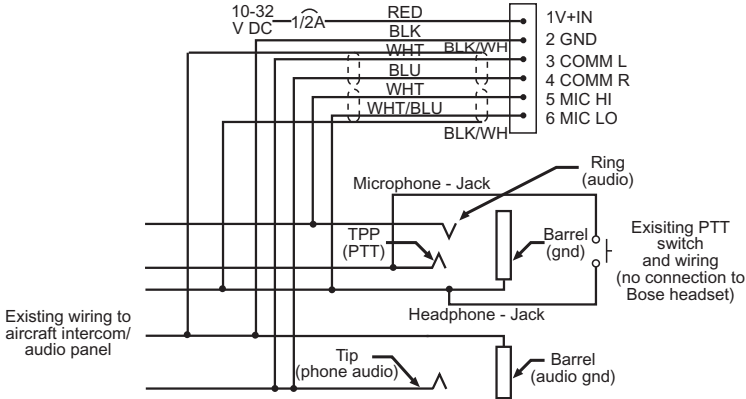

### Stereo connection diagram

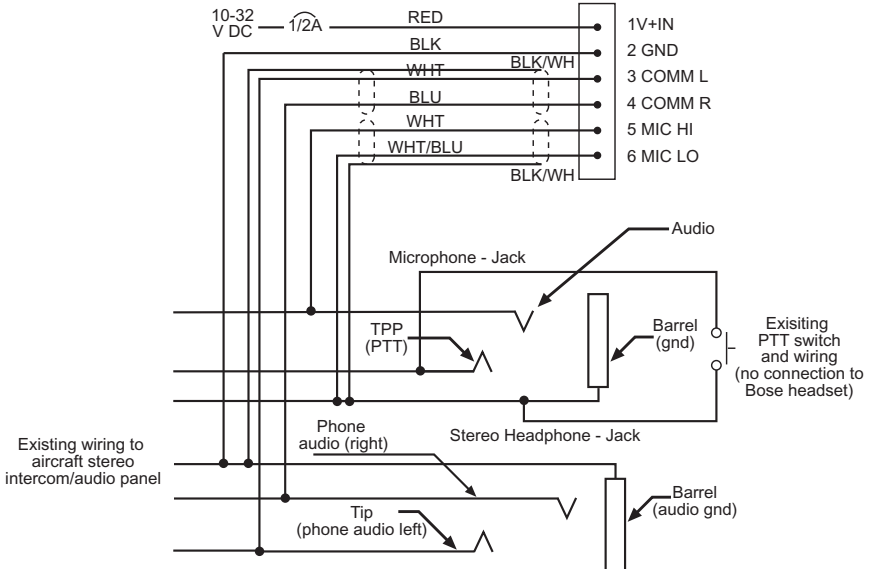

## Helicopter connection diagram

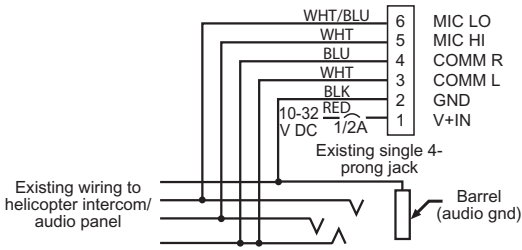

**Note:** Barrel ground (gnd) refers to aircraft grounds.

## Details on making the connections

The pinouts for the optional installed connector are detailed in the table below:

Pin number	Color	Purpose
1	Red	V+IN: Headset power (10-32 VDC). Use a ¼ amp fuse or a ½ amp circuit breaker.
2	Black	GND: System ground. Connect to the existing audio ground.
3	White	COMM L: Phone communication: Left.
4	Blue	COMM R: Phone communication: Right.

**Note:** For stereo operation, connect the left and right channels to their respective positions. For monaural operation, connect pins 3 and 4 together, and to the tip of the existing phone jack.

5	White	MIC HI: Microphone/Hi-audio. Connect to the portion of the existing microphone jack that corresponds to the ring position of a headset microphone plug. Do not connect to the tip (PTT) segment.
6	White/Blue	MIC LO: Microphone/Lo-ground. Connect to the portion of the microphone jack that corresponds to the barrel position of a headset microphone plug.

**Note:** If the microphone works on radio transmit but not through the intercom, check pin 6. It may be incorrectly wired to the PTT segment of the microphone jack.

Comm Shield	Black	Shield from Comm L and Comm R wire pair.
Mic Shield	Black	Shield from Mic Hi and Mic Lo wire pair.

**Note:** The wires connecting pins 3 and 4 and pins 5 and 6 are shielded, twisted pairs with a black wire shield termination exiting each pair. If the existing wiring is not shielded, connect the shields to the existing audio wiring shields, or connect the shield from Comm L and Comm R wire pair to audio ground.

## TECHNICAL INFORMATION

Headphone	Damage could occur to avionics equipment that is intended for use only with 600 Ohm headsets. If in doubt, consult the avionics equipment manufacturer.
Impedance	Monaural mode: 160 Ohms ON and OFF Stereo mode: 320 Ohms ON and OFF
Frequency response	15 Hz to 15 kHz Sensitivity: 92 dB SPL typical, measured at 1 mw, 1 kHz, full volume on a KEMAR ear simulator.
Microphone (Electret)	Bias required: 8 to 16 VDC through 220 to 2200 Ohms. Sensitivity: Varies depending on bias and AC radio input impedance. Typical output is 600 mV at 114 dB SPL. To assure proper modulation of the radio, it is recommended that an avionics technician adjust its input to match the output of the microphone.
Microphone (Dynamic)	Impedance: 5 Ohms Sensitivity: Equivalent to M-87/M-101
Maximum ambient noise level	115 dBC SPL for full active noise reduction performance
Power source	Battery-powered: 2 AA alkaline Aircraft-powered: 10 to 32 VDC
Voltage	Battery-powered: Two (2) AA alkaline batteries Aircraft-powered: 10 to 32 VDC
Battery life	Alkaline battery life: At least 40 hours in typical general aviation aircraft noise. Duration varies with battery age, ambient noise levels, temperature, and ear cushion seal.
Current	Operating: 25 mA in typical aircraft noise
Fuse/breaker recommended	¼ amp, fast-blow fuse (AGC ¼ amp fuse) or ½ amp circuit breaker
Headset weight	12 ounces
Headset size range	Breadth: 4.8 to 6.3 inches Height: 4.5 to 5.7 inches
Temperature and Altitude (Category A)	Operating: 5 to 131°F (-15 to 55°C) Storage: -67 to 158°F (-55 to 70°C) Altitude: 15,000 feet maximum pressure altitude for full cancellation
<i>Bluetooth</i> ® wireless technology	Hands-free profile, <i>Bluetooth</i> 2.1
<i>Bluetooth</i> technology QD ID	Bose® A20™ Aviation Headset: B016487

**FAA Technical Standards Order**

The Bose® A20™ Aviation Headset, its interface, cables, and electret microphone are FAA approved to TSO C139. It has been designed to function in or withstand exposure to the following environmental conditions:

<i>Condition</i>	<i>Category</i>
Altitude and Temperature	A1
Salt Fog	S
AF conducted susceptibility	B
Humidity	B
Magnetic effect	Z
Power input	B
RF susceptibility	T
Temperature and altitude	A1
Vibration	S, R, and U
Voltage spike	A
Shock drop	12 times, 1 m onto concrete

Environmental categories cited refer to RTCA/DO-160F and RTCA/DO-214 (March 2, 1993).

## SERVICE AND WARRANTY INFORMATION

---

### Locating the headset serial number

---

Your Bose® A20™ Aviation Headset is identified by a unique headset serial number located on the underside of the headband and underneath the headband cushion. Reference this serial number when you register your product or contact Bose for technical support.

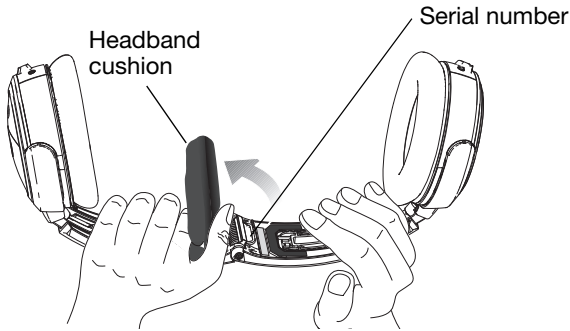

Be sure to properly reseat the headband cushion by pressing down firmly. For more information on replacing the headband cushion, see “Headband cushion replacement” on page 26.

### Warranty period

---

Your Bose A20 Aviation Headset is covered by a limited 5-year warranty. Details of the limited warranty are provided on the warranty/product registration card included in the product carton. Ear cushions carry a six-month limited warranty against manufacturer defects.

### Limited warranty service

---

#### To return your headset to Bose for repair

Return your headset using the following procedures:

1. Contact the Bose organization in your country/region (visit **Global.Bose.com** for Bose contact information in your country/region) for specific return and shipping instructions;
2. Label and ship the product, freight prepaid, to the address provided by the Bose organization in your country; and
3. Place any necessary return authorization number prominently on the outside of the carton. Cartons not bearing a return authorization number, where required, will be refused.



## Contact information

Contact Bose for:

- Spare parts and accessories
- Technical advice
- Installation information
- Warranty and repair information

In North America:

Bose® Technical Support  
145 Pennsylvania Avenue  
Framingham, MA 01701-9168 USA  
TEL: 1-800-233-4416 (US); 508-879-7330, ext. 62006 (outside US)  
FAX: 1-508-766-5997  
E-MAIL: [aviationheadsetsupport@Bose.com](mailto:aviationheadsetsupport@Bose.com)

In Europe:

Noise Reduction Technology Group  
Nijverheidstraat 8 NL-1135 GE Edam  
TEL: +31(0)299-390150  
FAX: +31(0)299-390109  
E-MAIL: [aviation\\_europe@Bose.com](mailto:aviation_europe@Bose.com)

World Wide Web: [www.Bose.com](http://www.Bose.com)

## Ordering parts and accessories

The following accessories and customer-replaceable parts can be purchased directly from Bose. See the contact information above.

- Additional control module cable
  - Specify: *Bluetooth*® technology or conventional module
  - Specify: connector type
- Ear cushion kit
- Headband cushion kit
- Carrying case
- Microphone windscreen
- Clothing clip
- Earcup access cover
- 6-pin connector to dual G/A plug cable adapter
- Service kit (includes ear cushion kit, microphone windscreen, and headband cushion kit)
- Aircraft panel connector installation kit
- Aircraft panel installation kit cover plate







325453-0010

***BOSE***<sup>®</sup>  
*Better sound through research*<sup>®</sup>

©2010 Bose Corporation, The Mountain,  
Framingham, MA 01701-9168 USA  
AM325453 Rev.01